

DeltaImpactFinder:
Assessing Semantic Merge Conflicts
with Dependency Analysis

Martín Dias,

Guillermo Polito, Damien Cassou, and Stéphane Ducasse

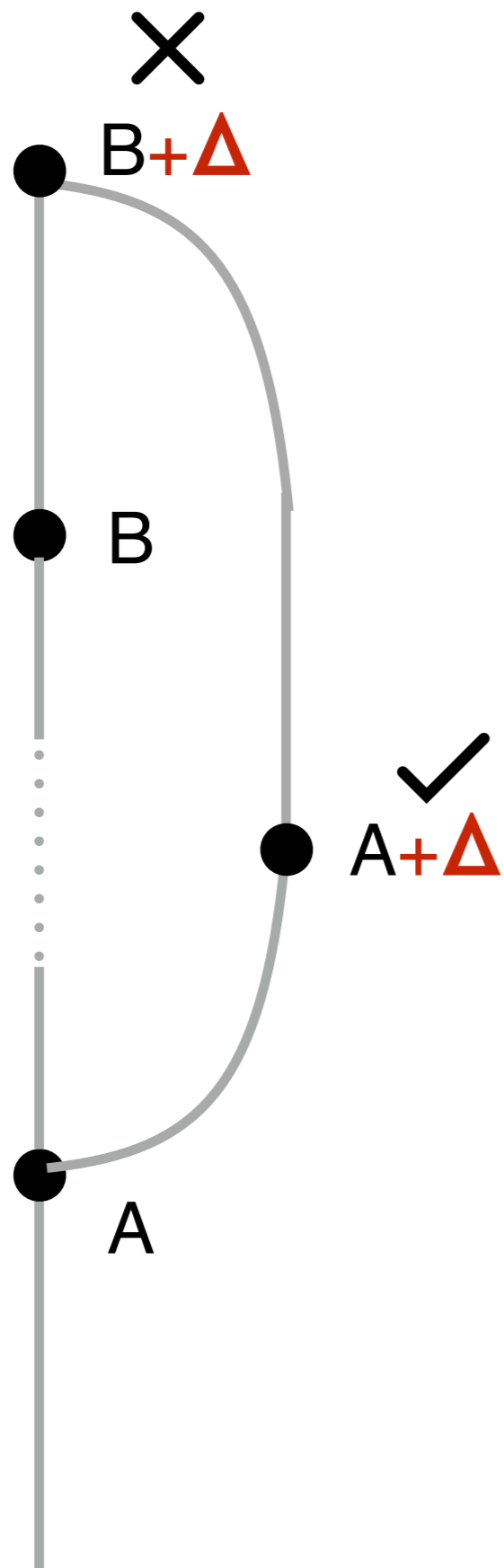

Structural conflicts

Compilation conflicts

Automatic test failures

Semantic Merge Conflicts

Example

```
| log |
```

```
log := FilteredLog new.
```

```
log filterBlock: [:each | each > 0 ].
```

```
log logAll: #(-5 -3 7 11).
```

```
log messages "--> #(7 11)." ✓
```

Log
messages
log:
logAll:

```
Object subclass: #Log  
  instanceVariableNames: 'messages'.
```

```
Log >> log: aMessage  
  messages add: aMessage.
```

```
Log >> logAll: newMessages  
  newMessages do: [:each | self log: each ].
```

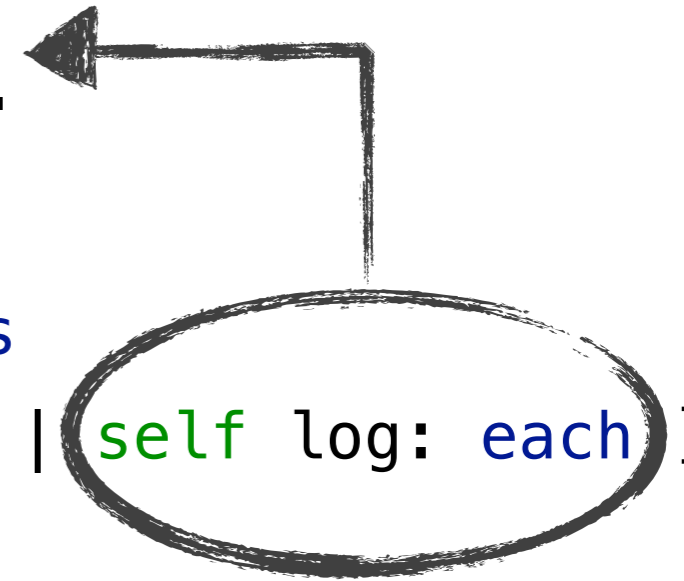

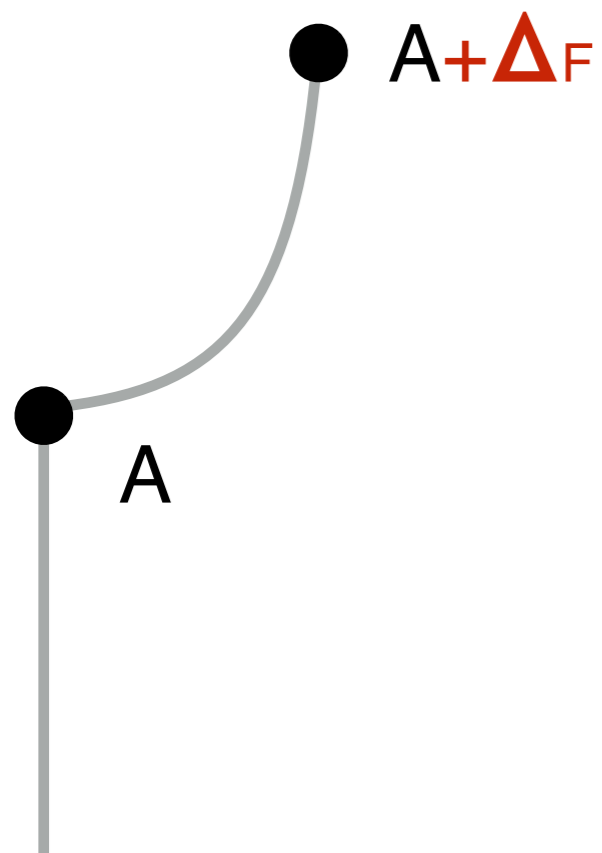
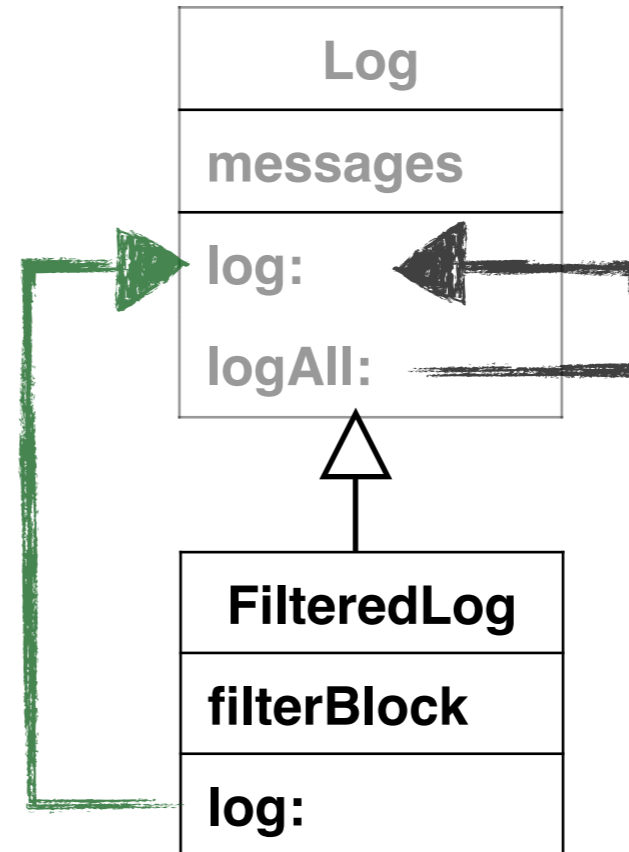

```

+ Log subclass: #FilteredLog
+   instanceVariableNames: 'filterBlock'.
  
```

```

+ FilteredLog >> log: aMessage
+   (filterBlock value: aMessage)
+   ifTrue: [ super log: aMessage ]
  
```

Log
messages
log:
logAll:

```
Log >> logAll: newMessages  
newMessages do: [:each | self log: each ]
```



A

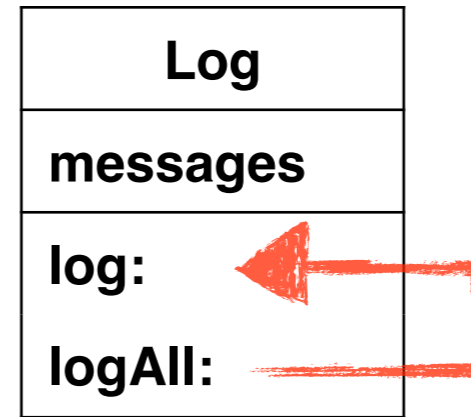

● B

```
Log >> logAll: newMessages
```

```
- newMessages do: [:each | self log: each]
```

```
+ messages addAll: newMessages
```

● A

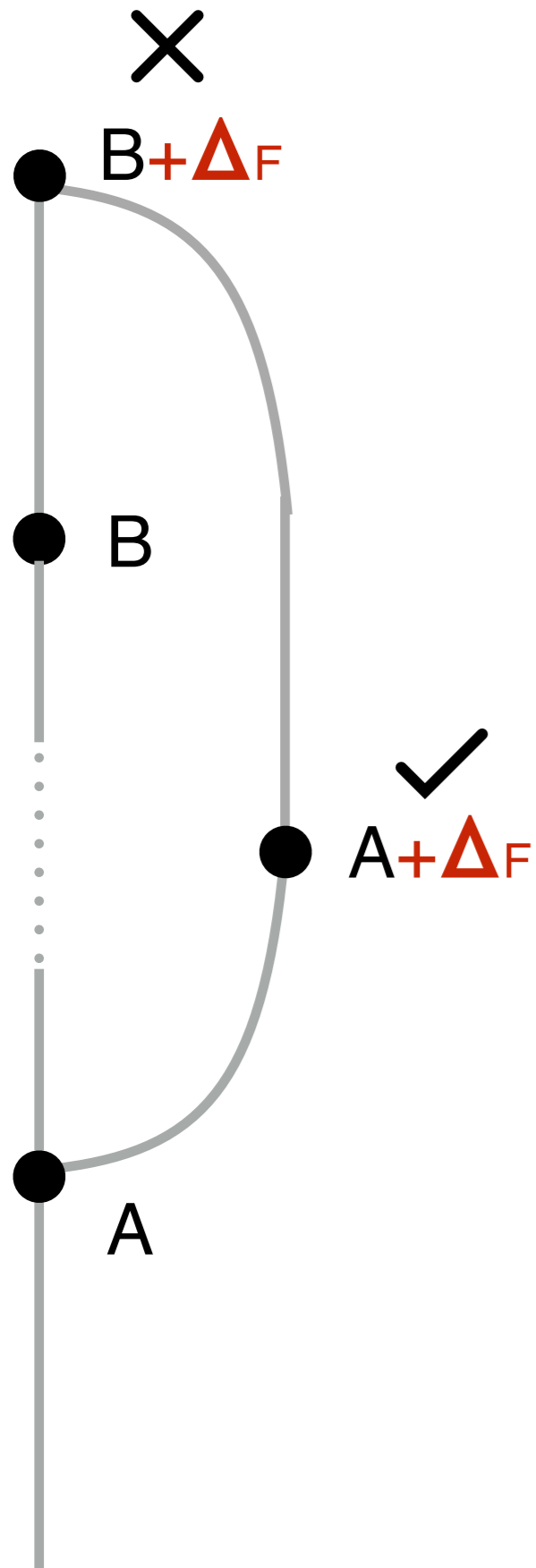

```
| log |  
log := FilteredLog new.  
log filterBlock: [:each | each > 0 ].
```

```
log logAll: #(-5 -3 7 11).
```

```
log messages "--> #(-5 -3 7 11)."
```

The developer needs to find that
Log >> logAll: changed in **B**

- It's hard to discover what change broke the code
- Sometimes test coverage is not good enough

DeltaImpactFinder

dependencies

impact

delta-impact

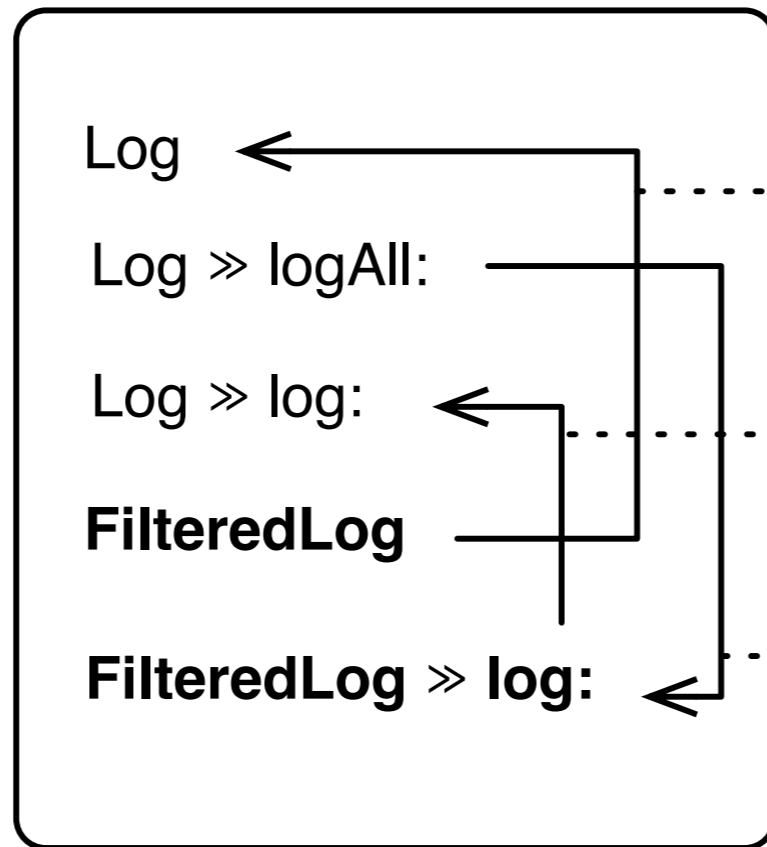
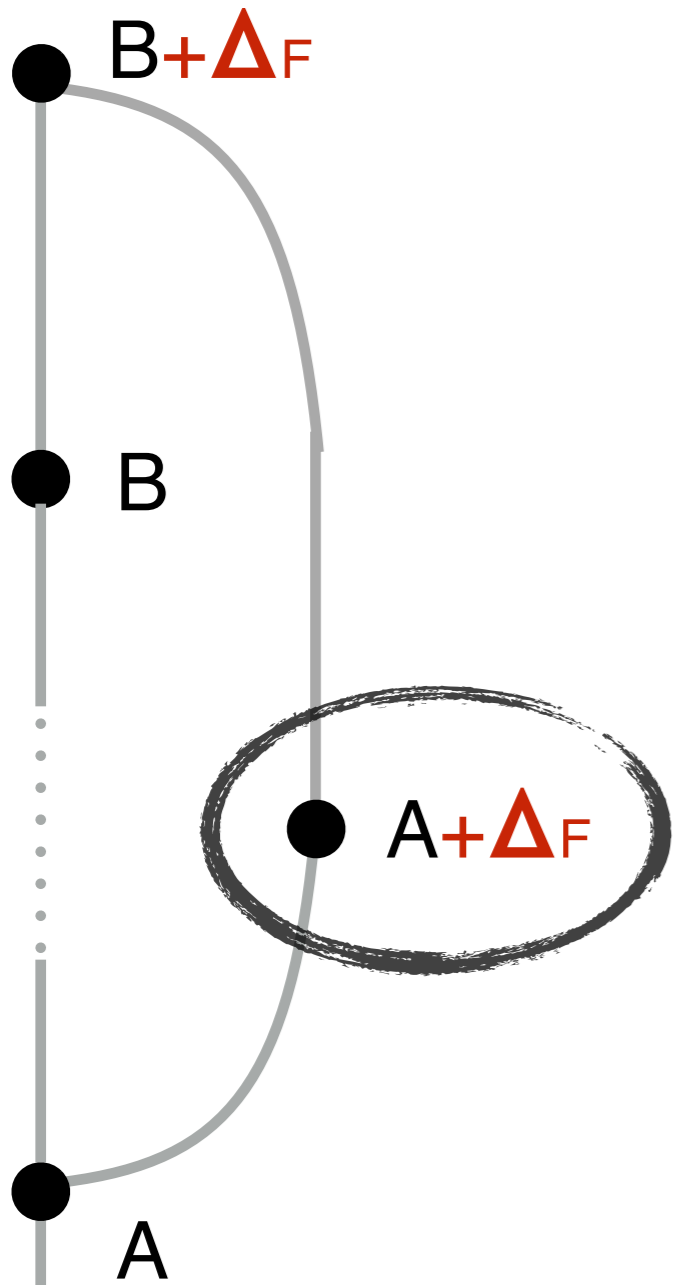

dependency

impact

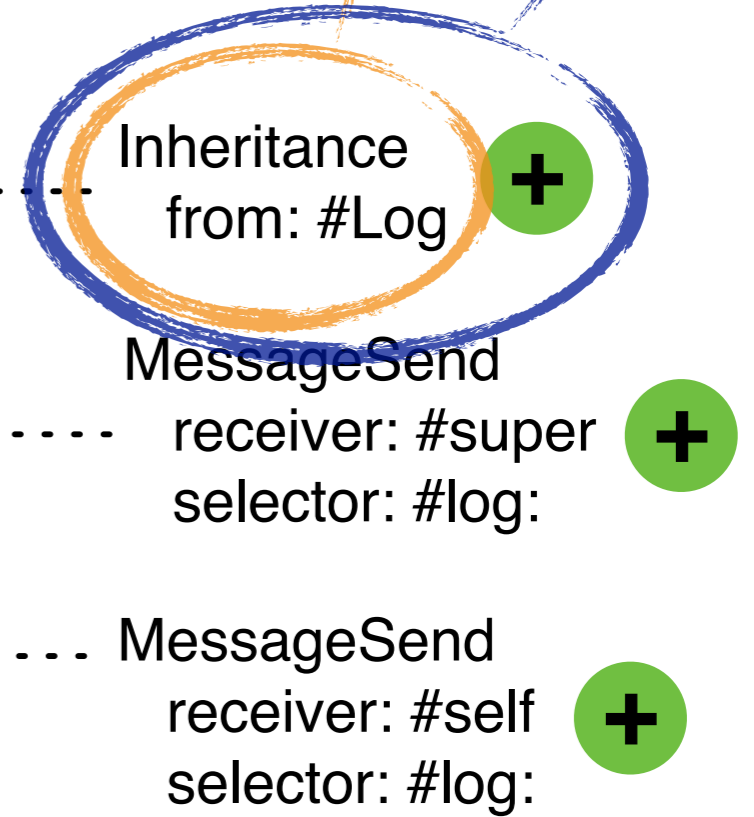

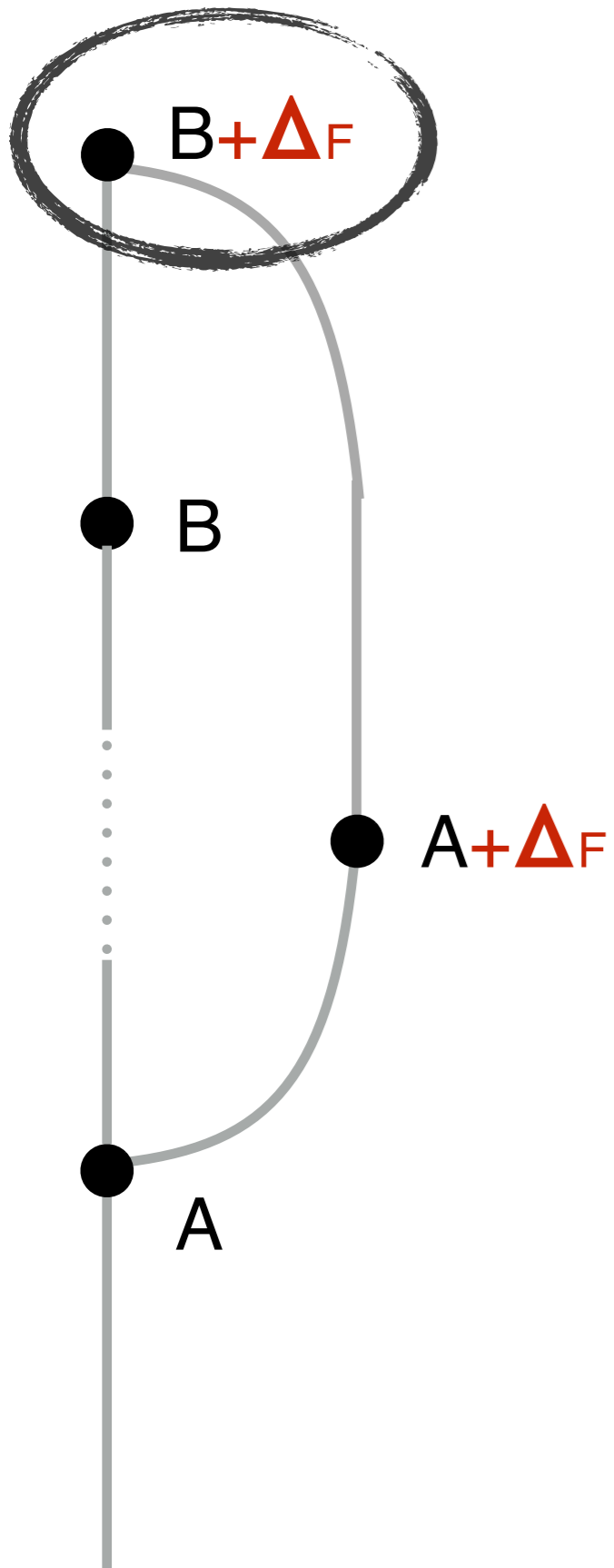

delta-impact

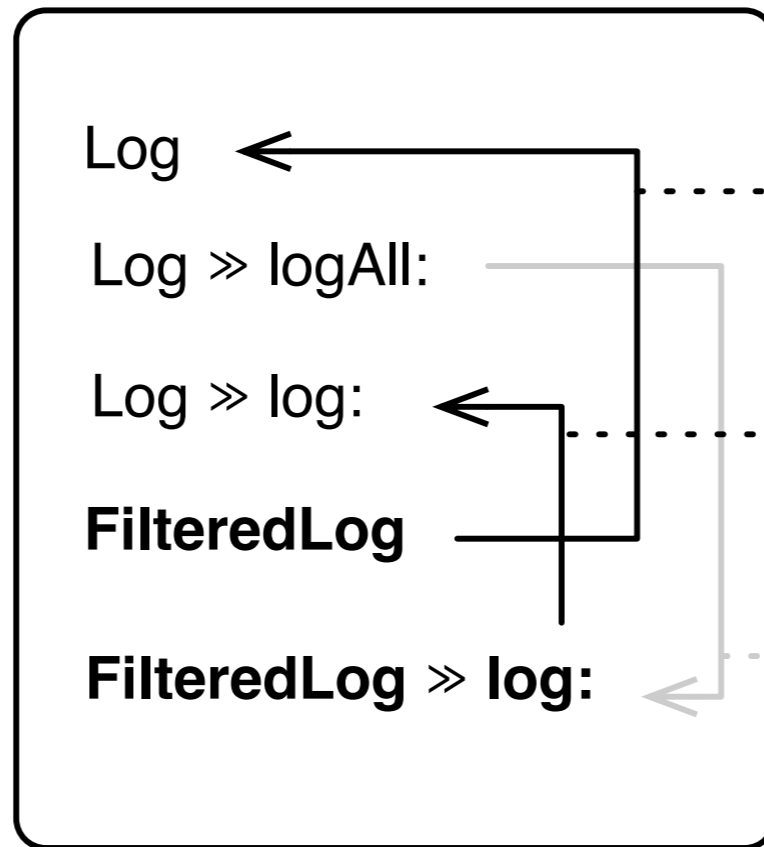

Inheritance
 from: #Log +

MessageSend
 receiver: #super
 selector: #log: +

MessageSend
 receiver: #self
 selector: #log: +

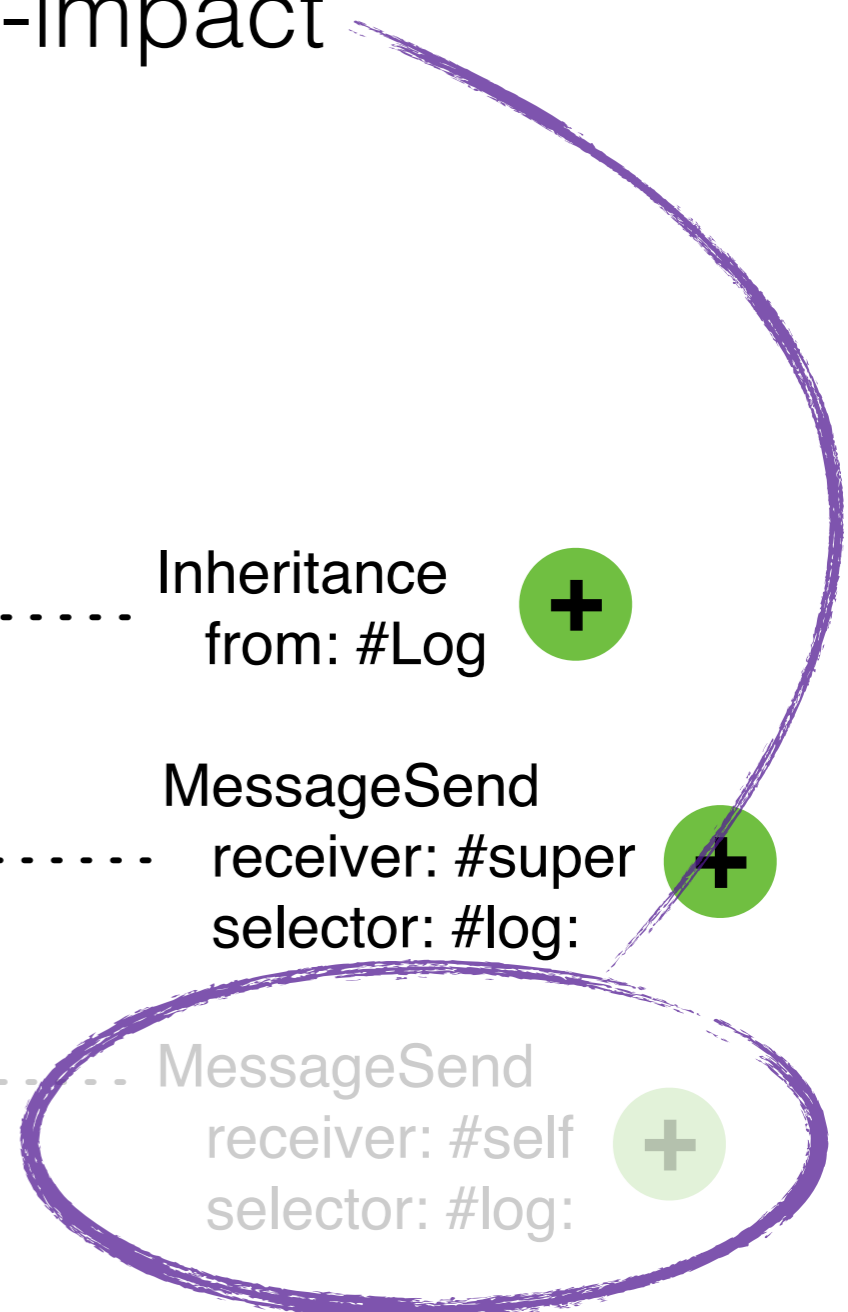

A B Δ_F

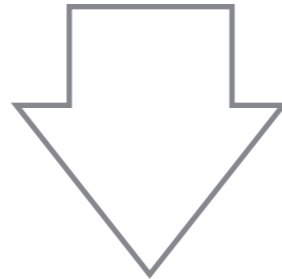

DeltaImpactFinder

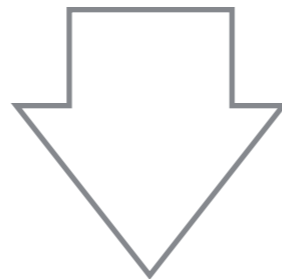

```
{ missing : Log>>logAll: -> FilteredLog>>log: }
```

Applicability

Aged Pharo Slices

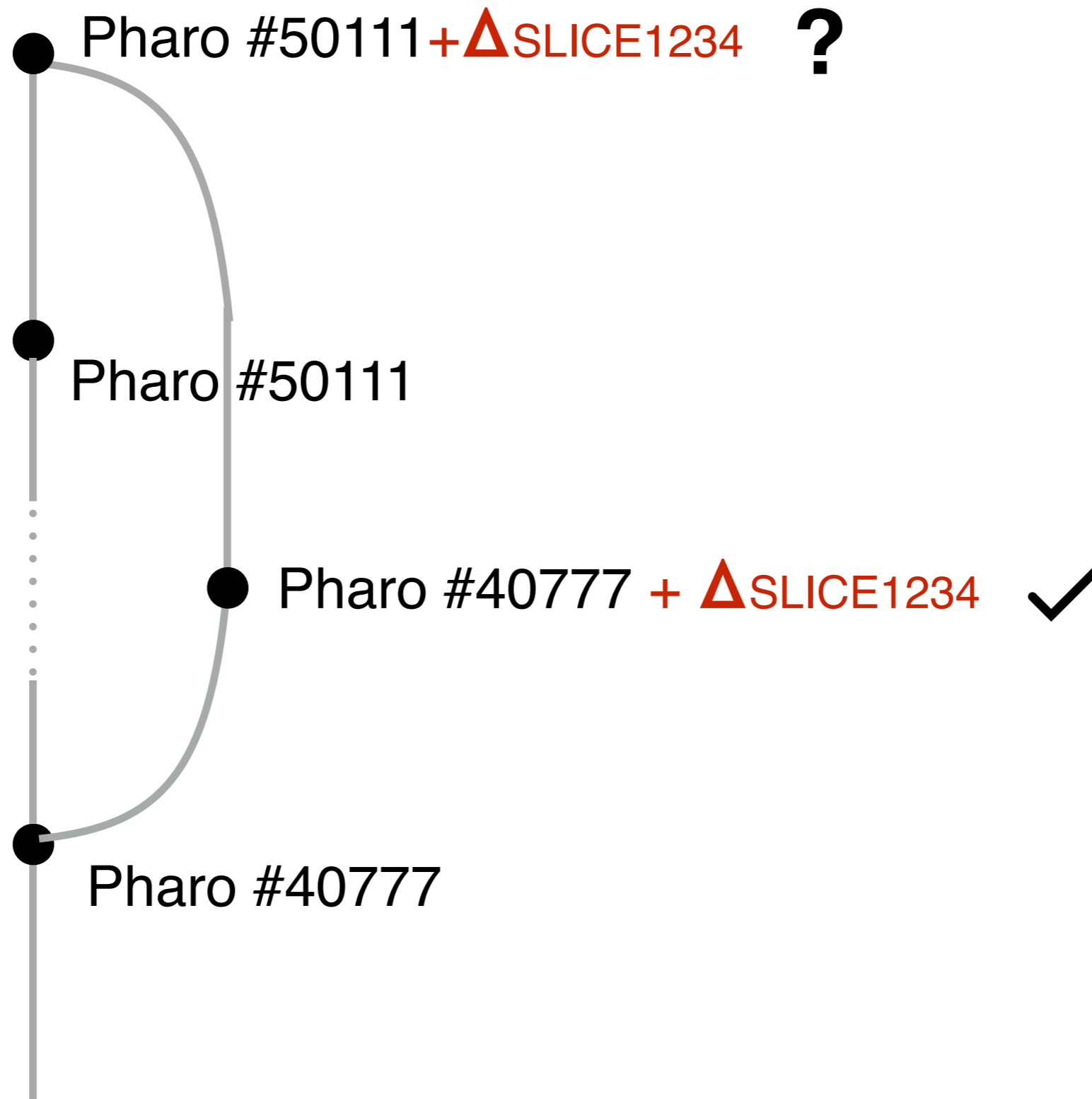

Migrate package to another Pharo version

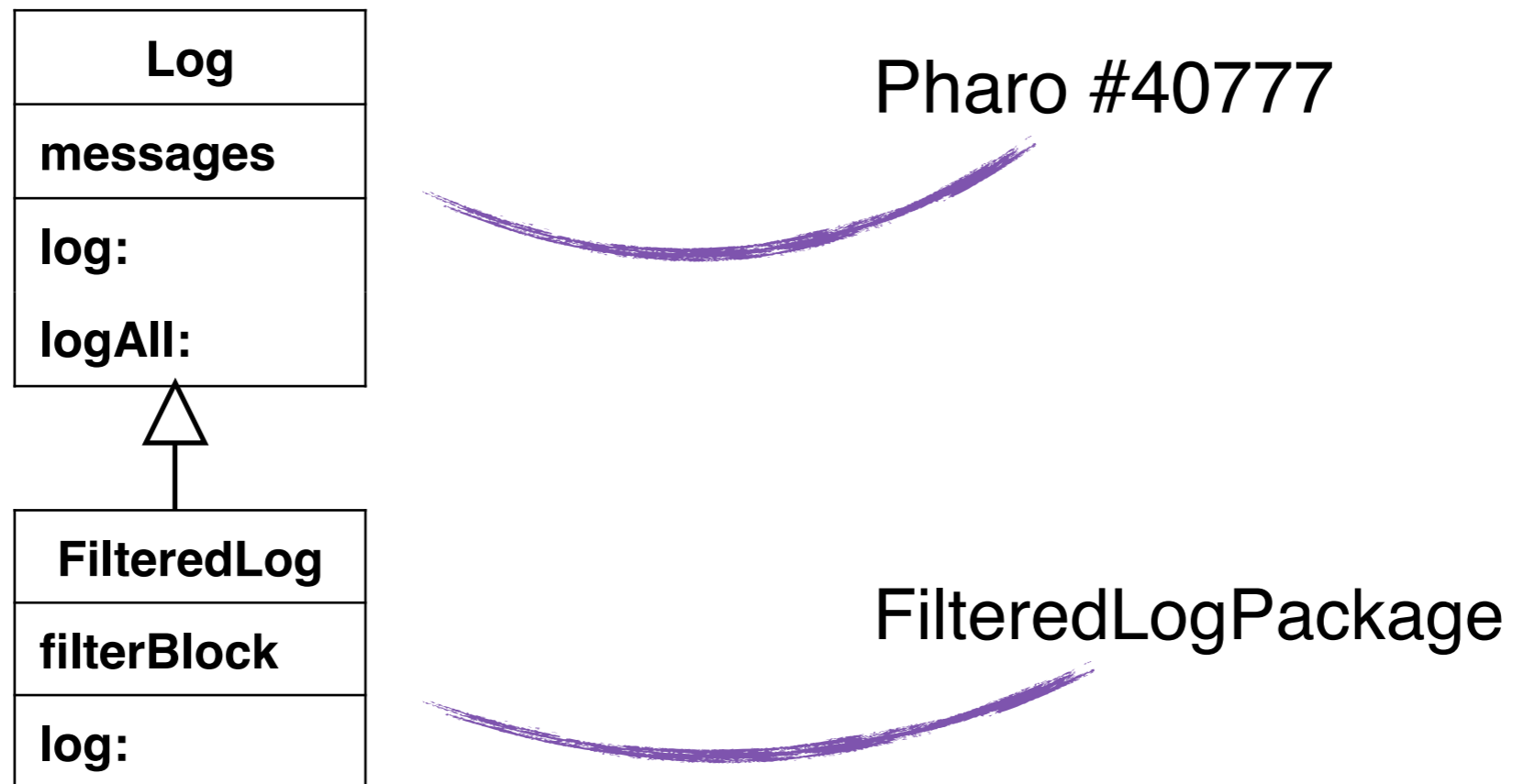

Migrate package to another Pharo version

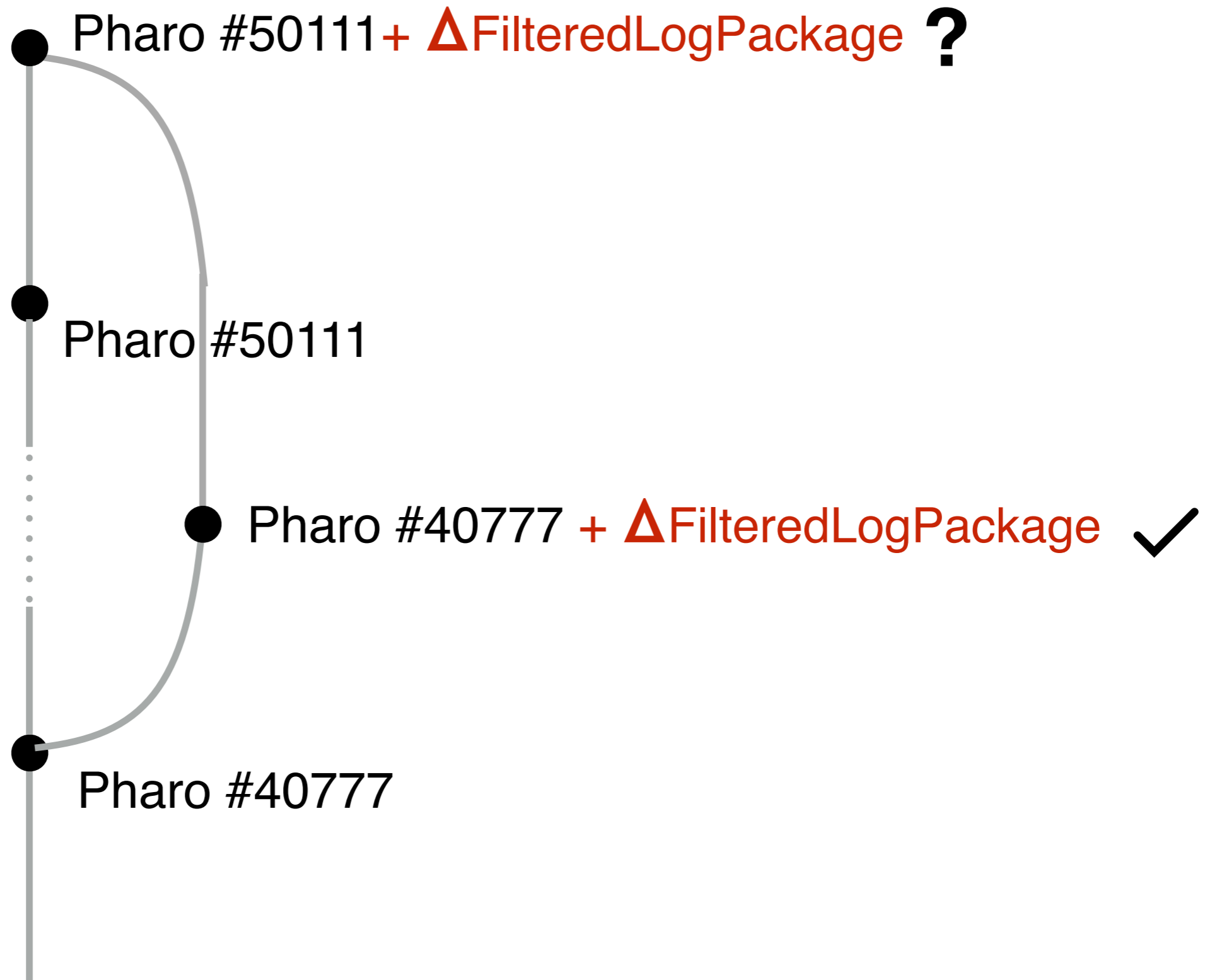

DeltaImpactFinder:
Assessing Semantic Merge Conflicts
with Dependency Analysis

Martín Dias,

Guillermo Polito, Damien Cassou, and Stéphane Ducasse